

MAGNUM

INDUSTRIAL

MODEL NO.: MI-81100

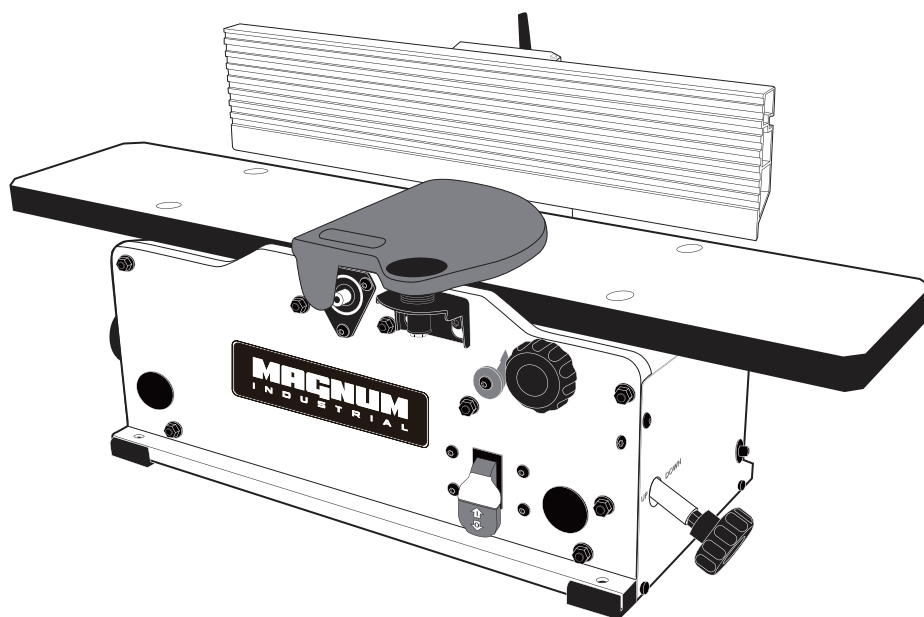

OPERATING MANUAL

GENERAL SAFETY

NOTE: The **WARNING!** and **CAUTION!** symbols indicate a potentially hazardous situation which, if not avoided, COULD result in death or serious injury. READ THIS MANUAL completely before assembling and operating this machine.

WARNING! TO AVOID serious injury, death, or damage to the machine, please read, understand, and follow, all Safety and Operating Instructions before assembling and operating this machine. This manual is not totally comprehensive. It does not and cannot convey every possible safety and operational problem which may arise while using this machine. The manual will cover many of the basic and specific safety procedures needed in an industrial environment.

All federal and state laws, and any regulations having jurisdiction covering the safety requirements for use of this machine, take precedence over the statements in this manual. Users of this machine must adhere to all such regulations.

WARNING! Exposure to the dust created by power sanding, sawing, grinding, drilling and other construction activities may cause serious and permanent respiratory or other injury, including silicosis (a serious lung disease), cancer, and death. Avoid breathing the dust, and avoid prolonged contact with dust. The dust may contain chemicals known to the State of California to cause cancer, birth defects or other reproductive harm.

Some examples of these chemicals are:

- Lead from lead-based paints.
- Crystalline silica from bricks, cement and other masonry products.
- Arsenic and chromium from chemically-treated lumber.

Always operate tool in well ventilated area and provide for proper dust removal. Use a dust collection system along with an air filtration system whenever possible. Always use properly fitting NIOSH/OSHA approved respiratory protection appropriate for the dust exposure, and wash exposed areas with soap and water.

WARNING! ALWAYS wear eye protection. Any machine can throw debris into the eyes during operations, which could cause severe and permanent eye damage. Everyday eyeglasses are NOT safety glasses. ALWAYS wear Safety Goggles (that comply with ANSI standard Z87.1) when operating power tools.

WARNING! ALWAYS wear hearing protection. Plain cotton is not an acceptable protective device. Hearing equipment should comply with ANSI S3.19 Standards.

WARNING! ALWAYS wear a NIOSH/OSHA approved dust mask to prevent inhaling dangerous dust or airborne particles.

GENERAL SAFETY (cont.)

ALWAYS keep the work area clean, well lit, and organized. DO NOT work in an area that has slippery floor surfaces from debris, grease, and wax.

CAUTION! ALWAYS unplug the machine from the electrical receptacle when making adjustments, changing parts or performing any maintenance.

AVOID ACCIDENTAL STARTING. Make sure that the power switch is in the “OFF” position before plugging in the power cord to the electrical receptacle.

WARNING! AVOID a dangerous working environment. DO NOT use electrical tools in a damp environment or expose them to rain or moisture.

WARNING! CHILDPROOF THE WORKSHOP AREA by removing switch keys, unplugging tools from the electrical receptacles, and using padlocks.

CAUTION! DO NOT use electrical tools in the presence of flammable liquids or gasses.

DO NOT FORCE the machine to perform an operation for which it was not designed. It will do a safer and higher quality job by only performing operations for which the machine was intended.

WARNING! DO NOT stand on a machine. Serious injury could result if it tips over or you accidentally contact any moving part.

DO NOT store anything above or near the machine.

WARNING! DO NOT operate any machine or tool if under the influence of drugs, alcohol, or medication.

EACH AND EVERY time, check for damaged parts prior to using any machine. Carefully check all guards to see that they operate properly, are not damaged, and perform their intended functions.

Check for alignment, binding or breakage of all moving parts. Any guard or other part that is damaged should be immediately repaired or replaced.

WARNING! Ground all machines. If any machine is supplied with a 3-prong plug, it must be plugged into a 3-contact electrical receptacle. The third prong is used to ground the tool and provide protection against accidental electric shock. DO NOT remove the third prong.

CAUTION! Keep visitors and children away from any machine. DO NOT permit people to be in the immediate work area, especially when the machine is operating.

GENERAL SAFETY (cont.)

KEEP protective guards in place and in working order.

CAUTION! MAINTAIN your balance. DO NOT extend yourself over the tool. Wear oil resistant rubber soled shoes. Keep floor clear of debris, grease, and wax.

MAINTAIN all machines with care. ALWAYS KEEP machine clean and in good working order. KEEP all blades and tool bits sharp.

NEVER leave a machine running, unattended. Turn the power switch to the OFF position. DO NOT leave the machine until it has come to a complete stop.

REMOVE ALL MAINTENANCE TOOLS from the immediate area prior to turning the machine ON.

WARNING! STAY ALERT, watch what you are doing, and use common sense when operating any machine. DO NOT operate any machine tool while tired or under the influence of drugs, alcohol, or medication. A moment of inattention while operating power tools may result in serious personal injury.

WARNING! USE ONLY recommended accessories. Use of incorrect or improper accessories could cause serious injury to the operator and cause damage to the machine. If in doubt, DO NOT use it.

THE USE of extension cords is not recommended for 230V equipment. It is better to arrange the placement of your equipment and the installed wiring to eliminate the need for an extension cord. If an extension cord is necessary, refer to the chart in the Grounding Instructions section to determine the minimum gauge for the extension cord. The extension cord must also contain a ground wire and plug pin.

CAUTION! Wear proper clothing, DO NOT wear loose clothing, gloves, neckties, or jewelry. These items can get caught in the machine during operations and pull the operator into the moving parts. Users must wear a protective cover on their hair, if the hair is long, to prevent it from contacting any moving parts.

SAVE these instructions and refer to them frequently and use them to instruct other users.

NOTE: Information regarding the safe and proper operation of this tool is also available from the following sources:

Power Tool Institute

American National Standards Institute

1300 Summer Avenue
Cleveland, OH 44115-2851
www.powertoolinstitute.org

23 West 43rd Street, 4th Floor
New York, NY 10036
www.ansi.org

National Safety Council
1121 Spring Lake Drive
Itasca, IL 60143-3201

ANSI 01.1 Safety Requirements for
Woodworking Machines and the
U.S. Department of Labor Relations
www.osha.gov

PRODUCT SAFETY

1. Serious personal injury may occur if normal safety precautions are overlooked or ignored. Accidents are frequently caused by lack of familiarity or failure to pay attention. Obtain advice from supervisor, instructor, or another qualified individual who is familiar with this machine and its operations.
2. Every work area is different. Always consider safety first, as it applies to your work area. Use this machine with respect and caution. Failure to do so could result in serious personal injury and damage to the machine.
3. Prevent electrical shock. Follow all electrical and safety codes, including the National Electrical Code (NEC) and the Occupational Safety and Health Regulations (OSHA). All electrical connections and wiring should be made by qualified personnel only
4. **WARNING!** TO REDUCE the risk of electrical shock. DO NOT use this machine outdoors. DO NOT expose to rain. Store indoors in a dry area.
5. STOP using this machine, if at any time you experience difficulties in performing any operation. Contact your supervisor, instructor or machine service center immediately.
6. Safety decals are on this machine to warn and direct you to how to protector yourself or visitors from personal injury. These decals MUST be maintained so that they are legible. REPLACE decals that are not legible.
7. DO NOT leave the unit plugged into the electrical outlet. Unplug the unit from the outlet when not in use and before servicing, performing maintenance tasks, or cleaning.
8. **WARNING!** DO NOT handle the plug or jointer with wet hands
9. USE only accessories as described in this manual and recommended.
10. DO NOT pull the jointer by the power cord. NEVER allow the power cord to come in contact with sharp edges, hot surfaces, oil or grease.
11. ALWAYS turn the power switch "OFF" before unplugging the jointer. DO NOT unplug the jointer by pulling on the power cord. ALWAYS grasp the plug, not the cord.
12. REPLACE a damaged cord immediately. DO NOT use a damaged cord or plug.
13. DO NOT use the jointer as a toy. DO NOT use near or around children.

PRODUCT SAFETY (cont.)

14. ENSURE that the machine sits firmly before using. If the machine wobbles or is unstable, correct the problem by attaching to a bench top prior to operation.
15. This machine is designed to process wood ONLY.
16. **WARNING!** NEVER position fingers or thumbs near the cutterhead.
17. Long pieces of stock should ALWAYS be supported with some type of fixture.
18. DO NOT operate jointer with dull or damaged blades.
19. MAKE CERTAIN that the jointer is properly adjusted prior to use.
20. DO NOT try and remove excessive amounts of wood in one single pass.
21. INSPECT all stock before beginning operations ensuring that there are no foreign objects embedded in the wood, loose knots, or knots that may become loose during operation.
22. **WARNING!** DO NOT attempt to remove jams until power is disconnected and all moving parts have come to a complete stop.
23. MAKE SURE that there is adequate operating space on both the infeed and outfeed sides of the jointer before operating.
24. **WARNING!** DO NOT attempt to joint or plane wood that is less than 10" long, narrower than $\frac{3}{4}$ ", or less than $\frac{1}{2}$ " thick.

GROUNDING INSTRUCTIONS

WARNING! This machine **MUST BE GROUNDED** while in use to protect the operator from electric shock. In the event of a malfunction or breakdown, **GROUNDING** provides the path of least resistance for electric current and reduces the risk of electric shock. The plug **MUST** be plugged into a matching electrical receptacle that is properly installed and grounded in accordance with **ALL** local codes and ordinances.

If a plug is provided with your machine **DO NOT** modify the plug. If it will not fit your electrical receptacle, have a qualified electrician install the proper connections to meet all electrical codes local and state. **ALL** connections must also adhere to **NEC** and **OSHA** mandates.

WARNING! **IMPROPER ELECTRICAL CONNECTION** of the equipment-grounding conductor can result in risk of electric shock. The conductor with the green insulation (with or without yellow stripes) is the equipment-grounding conductor. **DO NOT** connect the equipment-grounding conductor to a live terminal if repair or replacement of the electric cord or plug is necessary.

Check with a qualified electrician or service personnel if you do not completely understand the grounding instructions, or if you are not sure the tool is properly grounded.

WARNING! Electrocutation or fire could result if this machine is not grounded properly or if the electrical configuration does not comply with local and state electrical codes.

MAKE CERTAIN the machine is disconnected from power source before starting any electrical work.

MAKE SURE the circuit breaker does not exceed the rating of the plug and receptacle.

The motor supplied with your machine is a 115 volt, 60 hertz, single phase motor. Never connect the green or ground wire to a live terminal. A machine with a 115 volt plug should only be connected to an outlet having the same configuration as the plug.

WARNING! To reduce the risk of fire or electrical shock, use the proper gauge of extension cord. When using an extension cord, be sure to use one heavy enough to carry the current your machine will draw.

The smaller the gauge-number, the larger the diameter of the extension cord is. If in doubt of the proper size of an extension cord, use a shorter and thicker cord. An undersized cord will cause a drop in line voltage resulting in a loss of power and overheating.

CAUTION! **USE ONLY** a 3-wire extension cord that has a 3-prong grounding plug and a 3-pole receptacle that accepts the machine's plug. If you are using an extension cord outdoors, be sure it is marked with the suffix "W-A" ("W" in Canada) to indicate that it is acceptable for outdoor use.

GROUNDING INSTRUCTIONS (cont.)

Make certain the extension cord is properly sized, and in good electrical condition. Always replace a worn or damaged extension cord immediately or have it repaired by a qualified person before using it.

Protect your extension cords from sharp objects, excessive heat, and damp or wet areas.

MINIMUM RECOMMENDED GAUGE FOR EXTENSION CORDS (AWG)				
115 VOLT OPERATION ONLY				
	25' LONG	50' LONG	100' LONG	150' LONG
0 to 6 Amps	18 AWG	16 AWG	16 AWG	14 AWG
6 to 10 Amps	18 AWG	18 AWG	14 AWG	12 AWG
10 to 12 Amps	16 AWG	16 AWG	14 AWG	12 AWG

UNPACKING & INVENTORY

Check shipping carton and machine for damage before unpacking. Carefully remove packaging materials, parts and machine from shipping carton. Always check for and remove protective shipping materials around motors and moving parts. Lay out all parts on a clean work surface.

Remove any protective materials and coatings from all of the parts and the jointer. The protective coatings can be removed by spraying WD-40 on them and wiping it off with a soft cloth. This may need to be redone several times before all of the protective coatings are removed completely.

After cleaning, apply a good quality paste wax to any unpainted surfaces. Make sure to buff out the wax before assembly.

Compare the items to inventory figures and verify that all items are accounted for before discarding the shipping box.

NOTE: Some parts may already be installed on your machine. Go through the entire manual before calling.

If any parts are missing, do not attempt to plug in the power cord and turn "ON" the machine. The machine should only be turned "ON" after all the parts have been obtained and installed correctly.

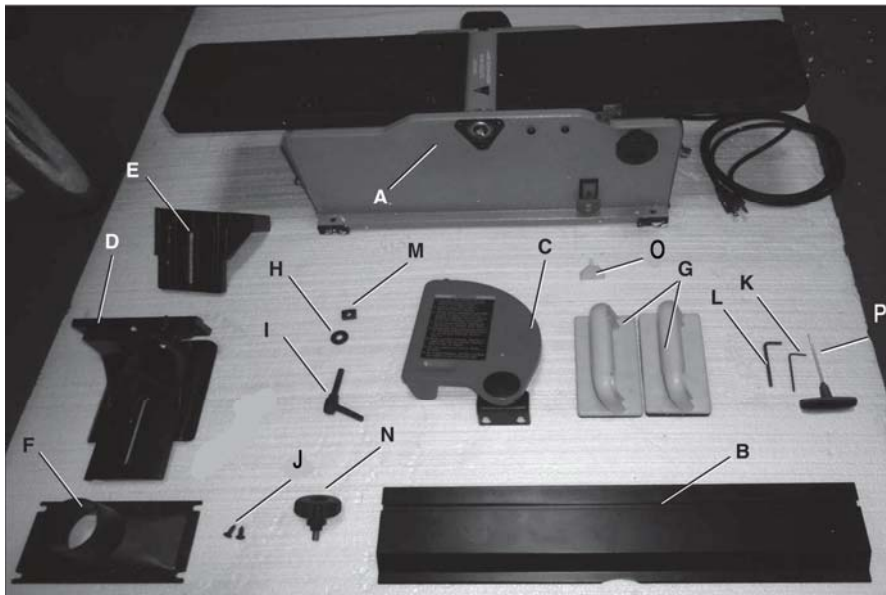

- | | | |
|--------------------------|--------------------------|----------------|
| A. Jointer | H. Flat Washer | O. Switch Key |
| B. Fence | I. Tilt Lock Lever Assy. | P. Torx Wrench |
| C. Cutterhead Guard | J. Soc Button head Screw | |
| D. Fence Sliding Bracket | K. 2.5mm Hex Wrench | |
| E. Fence Bracket | L. 4mm Hex Wrench | |
| F. Dust Port | M. Special Nut | |
| G. Push Blocks | N. Knob | |

ASSEMBLY

WARNING! MAKE CERTAIN THAT THE MACHINE IS DISCONNECTED FROM THE POWER SOURCE.

FENCE ASSEMBLY PROCEDURE

1. Assemble the fence bracket (A) to the jointer base (B). Remove the four Soc Button Head Screws (C) on the rear frame to lock the bracket in place. SEE FIG. 1

Fig. 1

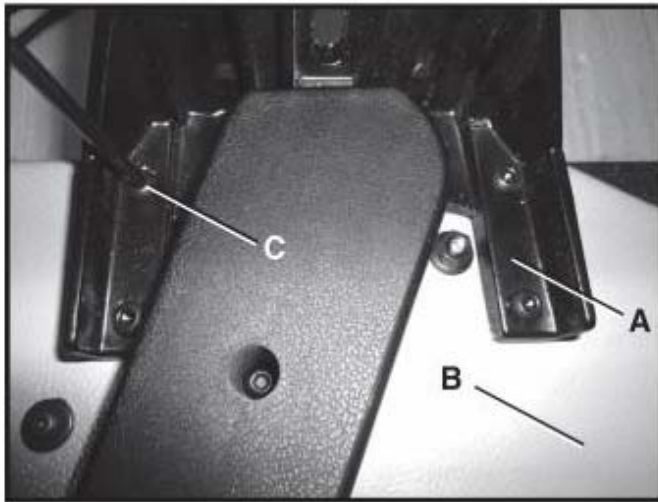

2. The square Nut (C) should fit in the groove of the fence. Assemble the fence sliding bracket (A) to the fence (B) SEE FIG. 2

Fig. 2

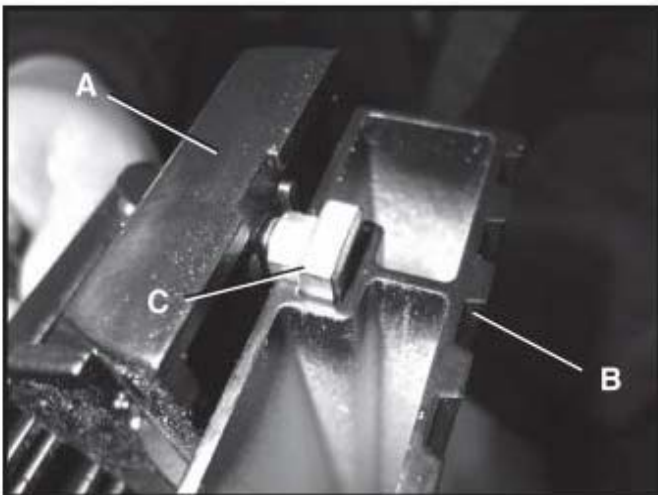

ASSEMBLY (cont.)

3. Adjust the fence sliding bracket (A) to the middle of the fence (B), referring to the center of fence cut-out (C) use two M6x16mm soc button head screws (D) to lock the sliding bracket in position. SEE FIG. 3

Fig. 3

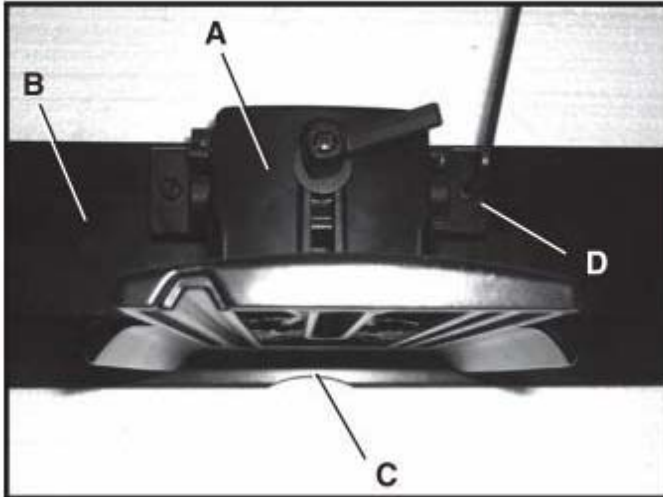

4. Locate the sliding bracket & fence assembly on to the mounting bracket on the body of the jointer. Insert the tilt lock lever assembly (A) with the flat washer (B) in place. SEE FIG. 4

Fig. 4

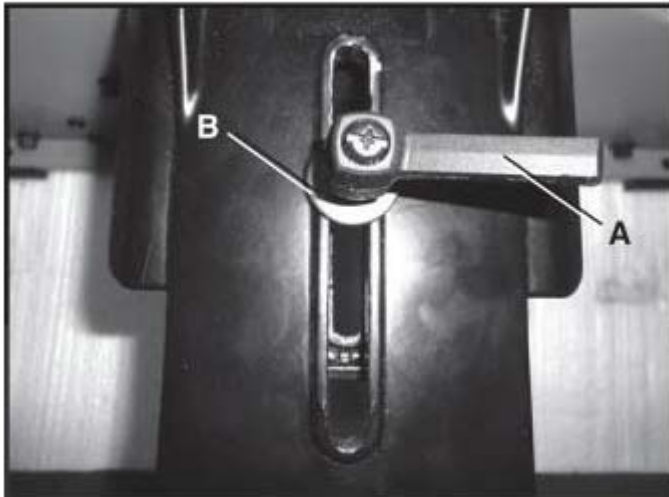

ASSEMBLY (cont.)

5. With the tilt lock lever assembly in between the mounting and sliding bracket, put on special nut (A), and turn the lever to lock both brackets into position. SEE FIG. 5

Fig. 5

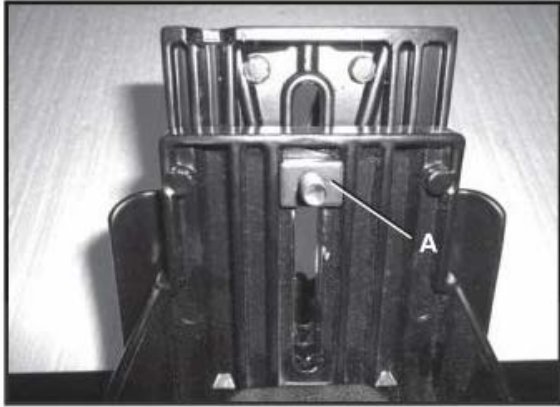

6. Use an angle gauge (A) to measure the 90° & 135° between the Fence and Jointer Table Top. Adjusting can be done by loosening or tightening the Hylock Hex Soc Head Screw (B). SEE FIG. 6 & 7

Fig. 6



Fig. 7



ASSEMBLY (cont.)

CUTTERHEAD GUARD ASSEMBLY

1. Attach cutterhead guard to the jointer by tightening the screw (A) SEE FIG. 8

Fig. 8



The cutterhead guard has a tension return spring. The tension on this spring is set at the factory. When the guard is installed properly it should return to the fence automatically after the work piece has passed over the cutterhead. Be sure the guard is functioning properly every time before using the jointer. If adjustment is necessary, remove the guard and while holding guard attachment base, rotate guard counter-clockwise to increase tension. Then mount guard base while holding guard and mounting base to prevent from losing tension.

DUST PORT ASSEMBLY

A dust port (A) is supplied with the jointer to help connect it to a standard 2-1/2 inch vacuum hose.

1. Tighten screws (B) by 4 mm hex wrench & screws (C) by phillips screwdriver when dust port (A) is in proper location. SEE FIG. 9

Fig. 9

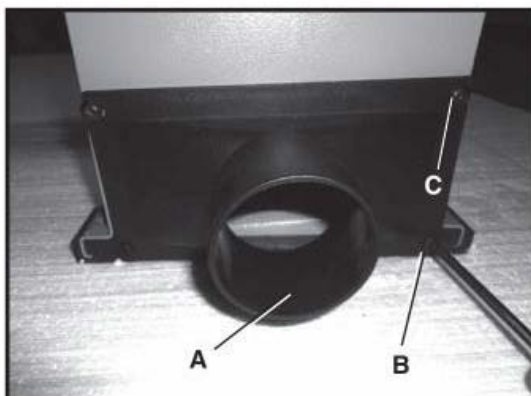

NOTE: Do not attach this dust port if you don't plan to use a dust collector.

ASSEMBLY (cont.)

LOCK KNOB ASSEMBLY

Attach knob (A) to the jointer by tightening the hex nut (B) by 10 mm, 13mm open end wrench (C). SEE FIG. 10 & 11

Fig. 10

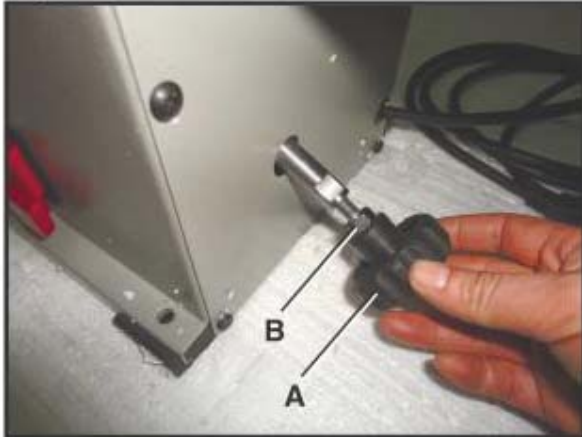

Fig. 11



SWITCH ASSEMBLY

The jointer is turned on by flipping the switch into the up position and it is turned off by flipping the switch in the down position. This jointer is also equipped with a special lockout toggle switch that prevents unauthorized use. To prevent unauthorized use of the jointer, simply pull out the yellow key (A) located on the face of the switch. SEE FIG 12.

Fig. 12



ADJUSTMENTS

WARNING! MAKE CERTAIN THAT THE MACHINE IS DISCONNECTED FROM THE POWER SOURCE BEFORE ANY ADJUSTMENTS ARE MADE.

FENCE ADJUSTMENTS

1. To move the fence across the table by loosening lock lever (A), slide the fence to the desired position on the table and tighten lock lever (A). SEE FIG 16.

Fig. 16

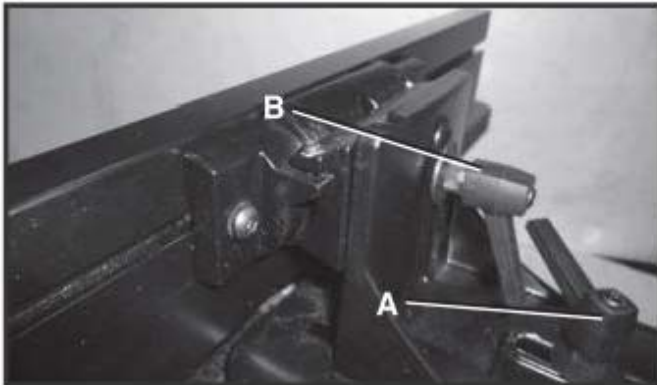

NOTE: Lock lever (A) and (B) can be repositioned by pulling up the lever and repositioning it on the nut located underneath the lever.

2. To tilt the fence, loosen tilt lock lever (B), and tilt the fence to the desired angle. Then tighten tilt lock lever (B) back SEE FIG 16.
3. The fence has adjustable positive stops at the most used fence positions of 90 and 135 degrees. To check and adjust the positive stops, proceed as follows:
4. Put a square (C) on the table with one end against the fence to adjust the fence until it is exactly 90 degrees to the table. SEE FIG 17.

Fig. 17

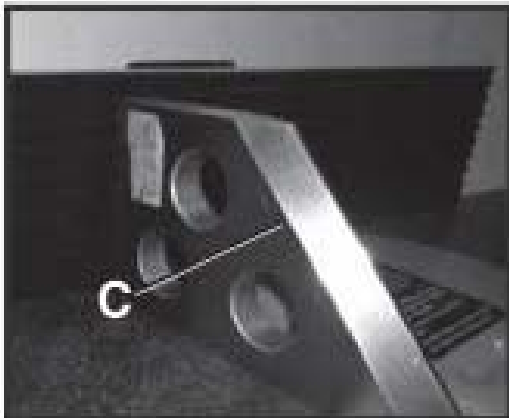
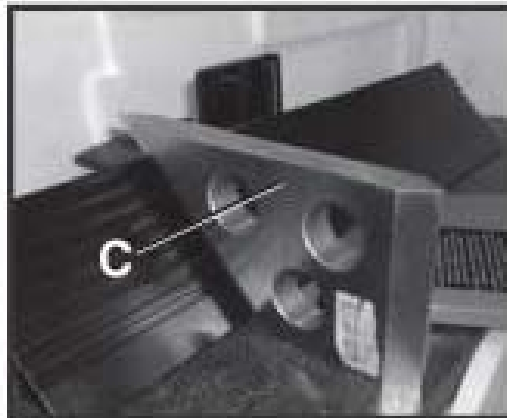

Fig. 18



ADJUSTMENTS (cont.)

5. Tighten set screw (D) by hex wrench until it contacts stop (E) SEE FIG 19.

Fig. 19

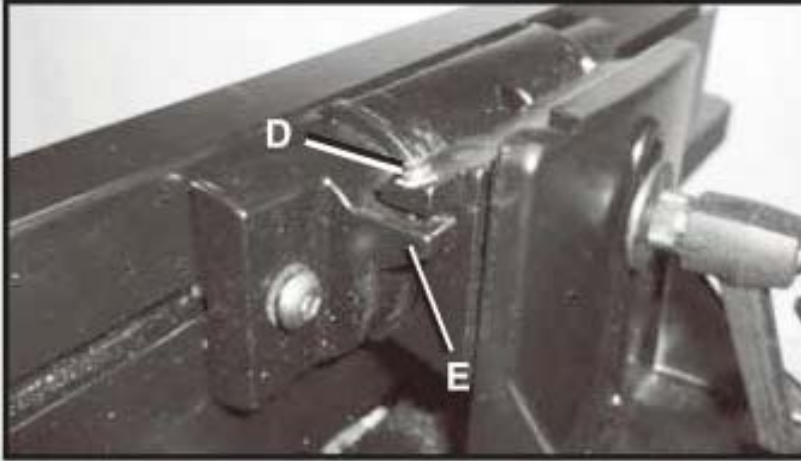

6. Put a square (C) on the table with one end against the fence to adjust the fence until it is exactly 135 degrees to the table. SEE FIG 18 on the previous page.
7. Tighten set screw (H) by hex wrench until it contacts stop (G) SEE FIG 20.

Fig. 20

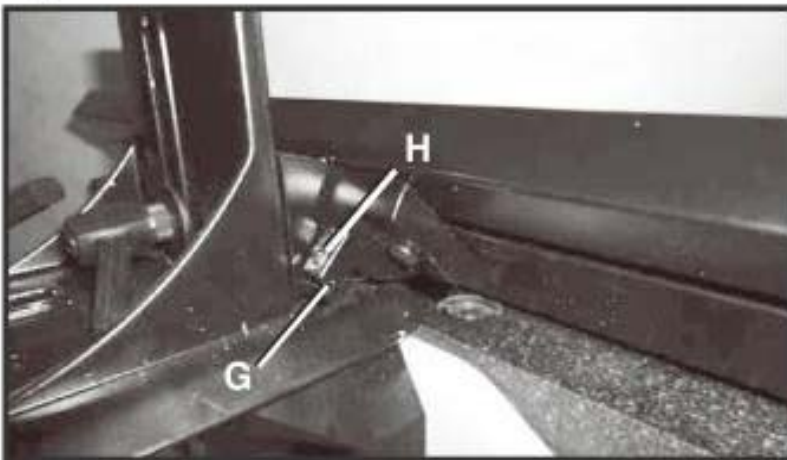

NOTE: These positive stops enable you to quickly position the table to the 90 and 135 degree settings.

OPERATIONS

NOTE: This operations section was designed to give instructions on the basic operations of this jointer. However, it is in no way comprehensive of every jointer operation. It is strongly recommended that you read books, trade magazines, or get formal training to maximize the potential of your jointer while minimizing the risks.

WARNING! NEVER PASS HANDS DIRECTLY OVER THE CUTTERHEAD.

WARNING! ALWAYS USE CUTTERHEAD GUARD, PUSH BLOCKS, AND KEEP HANDS AWAY FROM CUTTERHEAD.

NOTE: THE KNIVES ON THE JOINTER WILL NOT WEAR EVENLY BY FEEDING THE WOOD THROUGH THE SAME SPOT ON THE TABLE EVERY TIME. FEED THE WOOD THROUGH THE JOINTER AT DIFFERENT SPOTS ON THE TABLE BY REPOSITIONING THE FENCE WHEN POSSIBLE, TO HELP ELIMINATE UNEVEN WEAR OF THE KNIVES.

STARTING AND STOPPING JOINTER

1. The on/off switch (A) is located on the front of the jointer. To turn the jointer "ON", insert safety key and move switch (A) upwards.
2. To turn the jointer "OFF", move the switch downwards and remove key. SEE FIG 13.

Fig. 13

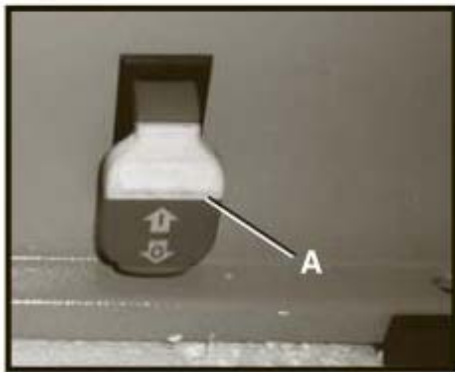

PLACEMENT OF HANDS DURING FEEDING

At the start of the cut, the left hand holds the work firmly against the infeed table and fence, while the right hand pushes the work toward the knives. After the cut is underway, the new surface rests firmly on the outfeed table. The left hand should then be moved to the work on the outfeed table, at the same time maintaining flat contact with the fence. The right hand presses the work forward, and before the right hand reaches the cutterhead, it should be moved to the work on the outfeed table.

OPERATIONS (cont.)

DIRECTION OF GRAIN

Avoid feeding work into the jointer against the grain. The result will be chipped and splintered edges. Feed with the grain to obtain a smooth surface. SEE FIG 14.

Fig. 14

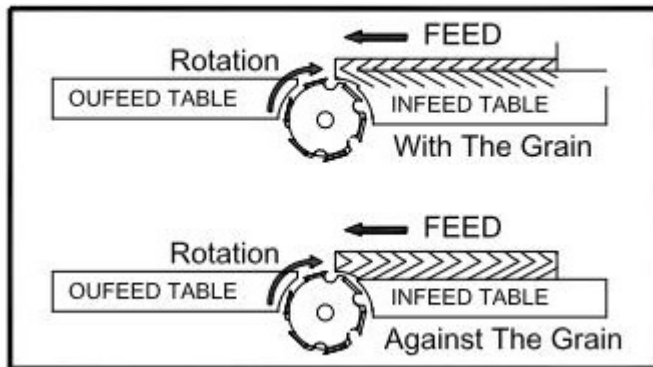

The jointer can be set to cut any depth from a very thin shaving to 1/8" deep. The pointer on the scale is to indicate the depth of cut. To adjust the depth of cut, loosen lock knob and turn adjusting knob clockwise to lower and counterclockwise to raise the infeed table until the infeed table is at the desired position. Retighten lock knob. SEE FIG 15.



FIG. 15

OPERATIONS (cont.)

PUSH BLOCKS

CAUTION! A set of push blocks (A) should be used whenever possible to minimize all danger to your hands. SEE FIG 21

Fig. 21

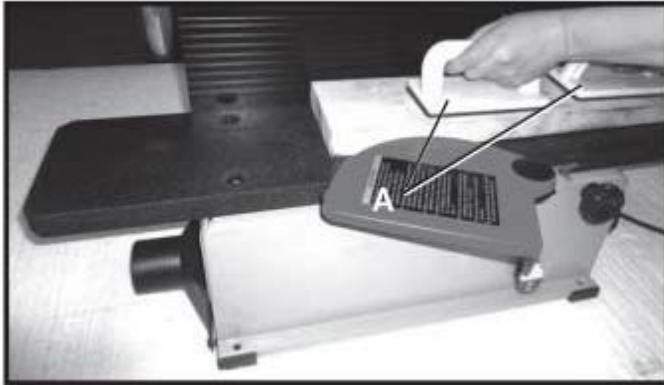

WARNING! ALWAYS USE PUSH BLOCKS WHEN PERFORMING SURFACING OPERATIONS AND NEVER PASS YOUR HANDS DIRECTLY OVER THE CUTTERHEAD.

JOINTING AN EDGE

This is the most common operation for the jointer. These cuts are made to square an edge of a work-piece. Set the guide fence square with the table. Depth of cut should be the minimum required to obtain a straight edge. Hold the best face of the piece firmly against the fence with push blocks throughout the feed. SEE FIG. 22.

Fig. 22



SURFACING / PLANING

Surfacing is similar to the edge jointing operation except for the position of the work piece. For surfacing, the major flat surface of the work piece is placed on the infeed table of the jointer with the narrow edge of the work piece against the fence. The work piece is moved from the infeed table, across the cutterhead to the outfeed table, establishing a flat surface on the work piece.

MAINTENANCE

WARNING! MAKE CERTAIN THAT THE MACHINE IS DISCONNECTED FROM THE POWER SOURCE BEFORE PERFORMING ANY MAINTENANCE PROCEDURES

Your jointer should provide you with a long time of service provided you take the time to perform the following maintenance operations.

CLEANING

Sawdust buildup and other debris can cause the tool to joint and plane incorrectly. Periodic cleaning and waxing is needed for accurate precision planing and jointing. Any moving parts should be cleaned regularly with penetrating oil and lubricated with a light coating of medium weight machine oil.

CAUTION! With the machine unplugged, blow off motor with low pressure air to remove dust or dirt. Air pressure above 50 P.S.I. should not be used as high-pressured air may damage insulation. The operator should always wear a respirator and eye protection when using compressed air. Do not allow chips and dust to accumulate under the machine. Keep area clean and in safe order.

Periodically clean, wax, and buff the tables. This will aid in the prevention of improper feeding of the work piece.

HARDWARE TIGHTNESS

Periodically check all clamps, nuts, bolts, and screws, for tightness and condition. Stop the machine and recheck the cutterhead screw and knives, or tips, for tightness after about 50 hours of operation. Recheck periodically.

MAINTENANCE (cont.)

WARNING! MAKE CERTAIN THAT THE MACHINE IS DISCONNECTED FROM THE POWER SOURCE BEFORE PERFORMING ANY MAINTENANCE PROCEDURES

BLADE REPLACEMENT

 **WARNING:**

To prevent serious personal injury

NEVER rotate the cutterhead by hand.

Blade are razor sharp! Always wear heavy leather gloves when handling the cutterhead. Avoid touching the cutter insert by hand without protection.

1. Remove blade guard.
2. To replace a knife, remove the cutterhead lock. Rotate cutterhead, loosen four screws and remove locking bar and knife. Replace new knife and install the locking bar back and tighten four screws.
3. To adjust the knives, make sure the cutterhead lock is not engaged, the screws are not overtightened, so knife can slide between locking bar and cutterhead.
4. Rotate cutterhead and engage cutterhead lock.
5. Place a straight edge on the outfeed table. Using wrench and turn screw until knife just contact straight edge. Adjust the remaining by the same way. Tighten four screws after adjustment is made.
6. Make sure cutterhead lock is disengaged after the adjustment is done and install the blade guard back.
7. Make certain that all knives are fastened properly on the cutterhead before turning on the machine.

MAINTENANCE (cont.)

Note: Proper cleaning is critical to achieving a smooth finish. Dirt or dust trapped between the cutter insert and cutterhead will slightly raise the cutter insert and make noticeable marks on your work piece the next time you use the machine.

REPLACING THE BELT

1. Use 4MM Allen Key to loosen the screw of belt guard. SEE FIG 23.



Fig 23

2. Push the belt outward, then screw the pulley on clockwise and disassemble the belt FIG 24



Fig 24

3. Ring the belt on the drive pulley. SEE FIGURE BELOW.



MAINTENANCE (cont.)

4. Press the belt on the cutterhead pulley. SEE FIG 26. Then rotate cutterhead pulley on clockwise and assemble the belt. SEE FIG 27.



Fig 26 & 27

5. Replace the belt guard. SEE FIG 28 and 29.



Fig 28 & 29

TROUBLESHOOTING GUIDE

Motor and Machine Operation

PROBLEM	LIKELY CAUSE	SOLUTION
Motor will not start.	Not plugged in. Blown circuit. Lockout key removed. Improper Voltage.	Check the power source. Replace fuse, reset breaker, or call electrician. Replace lockout key.
Fuses or circuit breaker blows.	Short circuit in line cord or plug. Unit overloaded.	Call electrician to repair or replace cord or plug for damaged insulation and shorted wires. Reduce load. Operate on circuit separate from other appliances or motors or connect to circuit with adequate amp rating.
Motor fails to develop full power	Power supply circuit overloaded with lights, appliances, and other motors. Undersized wires or circuits too long.	Reduce load on circuit. Increase wire sizes or reduce length of the circuit.
Motor overheats.	Motor overloaded during operation. Air circulation through the motor restricted.	Reduce load on motor; take lighter cuts. Clean out motor to provide normal air circulation.
Motor stalls or shuts off during a cut.	Motor overloaded during operation. Short circuit in motor or loose connections. Circuit breaker tripped.	Reduce load on motor; take lighter cuts. Call electrician to repair or replace connections on motor for loose or shorted terminals or worn insulation. Install correct circuit breaker; reduce number of machines running on that circuit (circuit overload)
Blade slows when cutting or makes a squealing noise on start-up.	V-belt worn out. Dull cutter tips.	Replace V-belt. Replace or rotate tips.

TROUBLESHOOTING GUIDE (cont.)

PROBLEM	LIKELY CAUSE	SOLUTION
Vibration when operating jointer	Loose or damaged cutter tip. Damaged belt. Worn cutterhead bearing.	Tighten or replace knife. Replace belt Check/replace cutterhead bearing.
Infeed table hard to adjust	Table lock is engaged or partially engaged.	Completely loosen the table lock.
Work piece stops at the beginning of the cut.	Outfeed table is too high.	Align outfeed table with cutterhead knife at the dead center.
Chipping or tear out	Knots or conflicting grain direction in wood. Nicked or chipped blades. Feeding work piece too fast Taking too deep of a cut.	Inspect work piece for knots and grain; only use clean stock. Rotate or replace knife. Slow down the feed rate. Take a smaller depth for cut(always reduce cutting depth when surface planing or working with hard woods)
Fuzzy grain.	Wood may have high moisture content. Dull knives.	Check moisture content and allow to dry if moisture is too high. Replace knives.
Long lines or ridges that run along the length of the board.	Nicked, worn, or chipped knives.	Rotate or replace cutter tips.
Uneven cutter marks, wavy surface, or chatter marks across the face of the board.	Feeding work piece too fast Knives not adjusted at even heights in the cutterhead.	Slow down the feed rate Clean and adjust the knives so they are set evenly in the cutterhead.
Board edge is concave or convex after jointing	Board not held with even pressure on infeed and outfeed table during cut. Board has excessive bow or twist along its length.	Hold board with even pressure as it moves over the cutterhead. Take partial cuts to remove the high spots before a full pass. Surface plane one face so there is a good surface to position against the fence. It may take 3 to 5 passes to achieve a perfect edge depending on the condition of the board and the depth of cut.

PARTS LIST FOR MI-81100

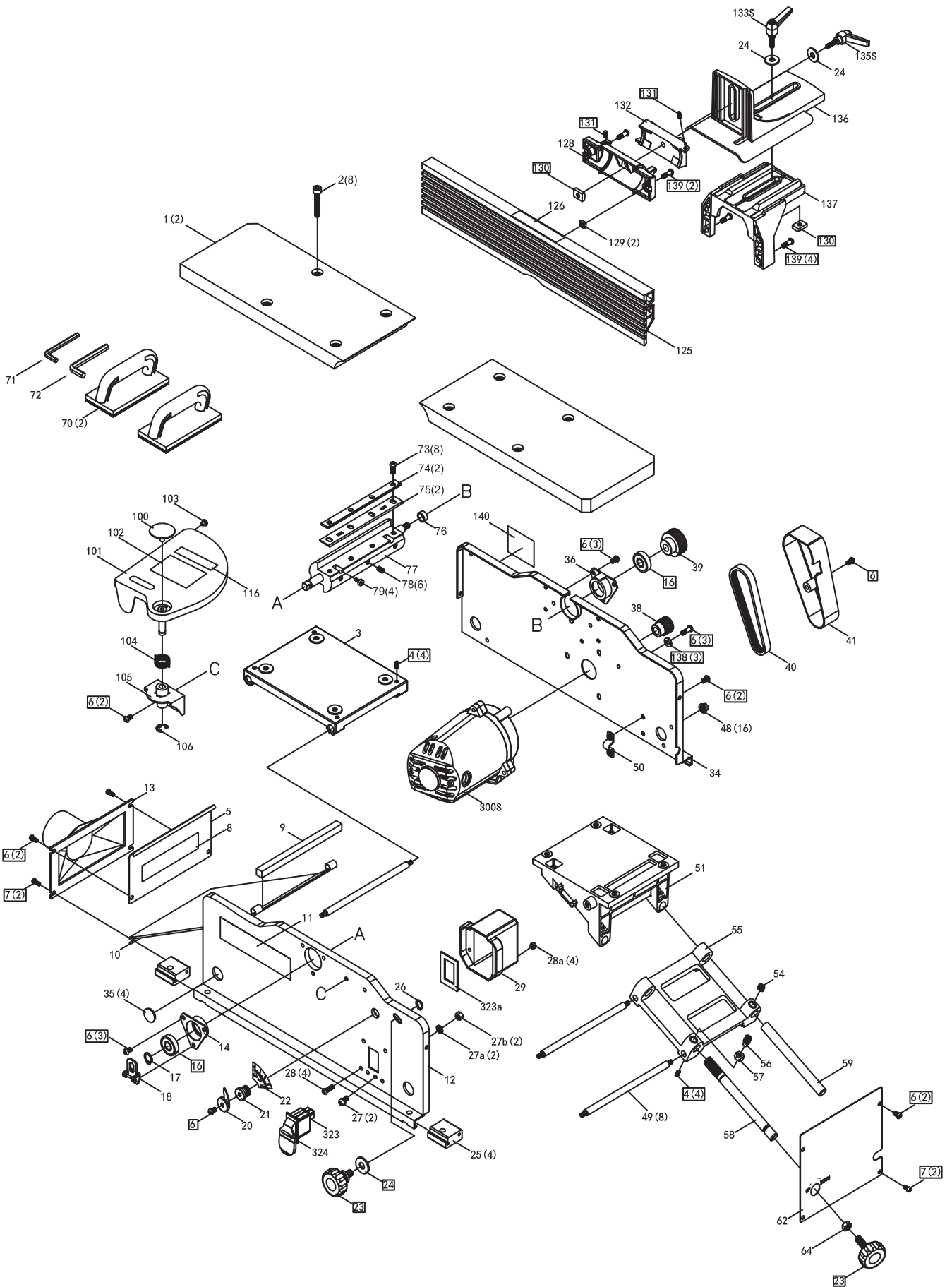

PARTS LIST FOR MI-81100

ITEM NO.	DESCRIPTION	SIZE	Q'ty
MI-81100-001	TABLE		2
MI-81100-002	SOC HEAD SCREW	M8x30L	8
MI-81100-003	OUTFEED SUPPORT		1
MI-81100-004	HEX SOC SET SCREW	M6xP1.0x8L	8
MI-81100-005	LEFT COVER		1
MI-81100-006	BUTTON HD SCREW	M6xP1.0x12L	19
MI-81100-007	SELF TAP SCREW		4
MI-81100-008	WARNING LABEL		1
MI-81100-009	FOAM SEAL		1
MI-81100-010	DUST CHUTE		1
MI-81100-011	LOGO		1
MI-81100-012	FRONT FRAME		1
MI-81100-013	DUST PORT		1
MI-81100-014	BEARING RETAINER		1
MI-81100-016	BEARING		2
MI-81100-017	EXTERNAL RETAINING RING		1
MI-81100-018	CUTTERHEAD LOCK		1
MI-81100-020	POINTER		1
MI-81100-021	GEAR		1
MI-81100-022	DEPTH SCALE		1
MI-81100-023	LICK KNOB	M8*P1.25*18L	2
MI-81100-024	FLAT WASHER	M8*23*2T	3
MI-81100-025	FOOT		4
MI-81100-026	EXT RETAINING RING		1
MI-81100-027	Phillips Button Screw	M5*P0.8*8L	2
MI-81100-027a	LOCK WASHER EXT	M5	2
MI-81100-027b	Hex Nut	M5	2
MI-81100-028	Hex Socket Button Screw	M5*P0.8*25L	4
MI-81100-028a	ANTI-LOOSE HEX NUT	M5	4
MI-81100-029	SWITCH BOX		1
MI-81100-034	REAR FRAME		1
MI-81100-035	HOLE PLUG		4
MI-81100-036	BEARING RETAINER ASSY.		1
MI-81100-038	MOTOR PULLEY		1
MI-81100-039	CUTTERHEAD PULLEY		1
MI-81100-040	BELT	125J5	1
MI-81100-041	BELT GUARD		1
MI-81100-048	HWX FLANGE	M6	16
MI-81100-049	TIE ROD		8
MI-81100-050	CORD CLAMP		1
MI-81100-051	INFEED SUPPORT		1
MI-81100-054	HEX SOC SET SCREW	M6*10L	1
MI-81100-055	BRACKET		1
MI-81100-056	HEX SOC SET SCREW	M6*16L	1
MI-81100-057	HEX NUT	M6	1
MI-81100-058	ADJUSTING ROD		1
MI-81100-059	SHAFT		1
MI-81100-062	RIGHT COVER		1
MI-81100-064	HEX NUT	M8*P1.25*13	1
MI-81100-070	JOINTER PUSH BLOCK		2

PARTS LIST FOR MI-81100

ITEM NO.	DESCRIPTION	SIZE	Q'ty
MI-81100-071	HEX WRENCH	2.5MM	1
MI-81100-072	HEX WRENCH	4MM*100L	1
MI-81100-073	SOC BUTTON HD SCREW	1/4x20NCx5/8""	8
MI-81100-074	CLAMP BAR		2
MI-81100-075	KNIVES	SK5	2
MI-81100-076	SPACER		1
MI-81100-077	CUTTERHEAD		1
MI-81100-078	HEX SOC SET SCREW	M6X10L	6
MI-81100-079	KNIFE ADJUSTER	M4X10L	4
MI-81100-100	HOLE PLUG		1
MI-81100-101	GUARD ASSY		1
MI-81100-102	WARNING LABEL		1
MI-81100-103	BUMPER SHOE		1
MI-81100-104	SPRING		1
MI-81100-105	BRACKET		1
MI-81100-106	EXT RETAINING RING		1
MI-81100-116	LABEL		1
MI-81100-125	FENCE		1
MI-81100-126	CAUTION LABEL		1
MI-81100-128	BEVEL BRACKET		1
MI-81100-129	SQUARE NUT		2
MI-81100-130	SPECIAL NUT		2
MI-81100-131	HYLOK HEX SOC HD SCREW	M5*P0.8*8L	2
MI-81100-132	INTERMEDIATE BRACKET		1
MI-81100-133S	TILT LOCK LEVER ASSY.	30L	1
MI-81100-135S	TILT LOCK LEVER ASSY.	40L	1
MI-81100-136	FENCE SLIDE BRACKET		1
MI-81100-137	FENCE BRACKET		1
MI-81100-138	FLAT WASHER	M6*.12.5*2.0T	3
MI-81100-139	SOC BUTTON HD SCREW	M6X16L	6
MI-81100-140	NAMEPLATE		1
MI-81100-319	BRUSH HOLDER		2
MI-81100-320	BRUSH	6.3*10.8*20L	2
MI-81100-321	BRUSH COVER		2
MI-81100-300S	MOTOR ASSY.	120V 60Hz	1
MI-81100-323	SWITCH		1
MI-81100-323a	SWITCH COVER		3
MI-81100-324	SWITCH KEY		1